

2022 NEW PRODUCTS

RL96A-10

- ▶ Drill your own mounting bores
- ▶ 248 mm diameter x 30 mm
- ▶ Made of Aluminum
- ▶ Maximize efficiency with Rocklock system



\$979
MSRP

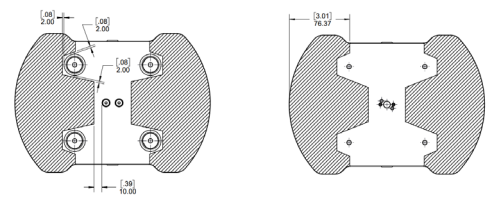

R96-BR

- ▶ 4 - PS20F Integrated
- ▶ 7.87" dia



\$319
MSRP

R96-BL

- ▶ 8 - PS20F Integrated
- ▶ For 3-axis and HMC



\$479
MSRP

V562X-5RG

- ▶ Compatible with V562X and V510X
- ▶ Clamping from 1.5-8" dia
- ▶ Replacement components available

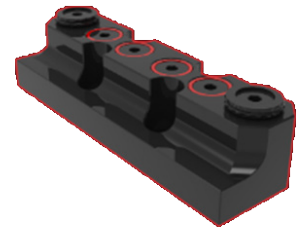

\$229
MSRP ea
(Need 2)

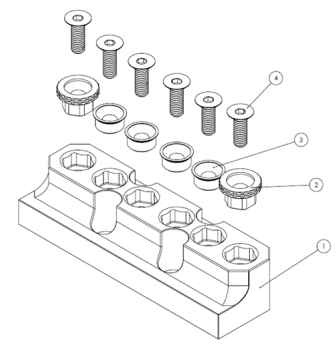

3R5AX-350

- ▶ 350mm x 350mm System 3R Pallet
- ▶ Compatible with Dynafix by System 3R
- ▶ Made of Aluminum



\$2,200
MSRP

RL96A-3RP20

- ▶ 381mm dia
- ▶ Fully integrated 3-sided Rocklock pyramid (96mm spacing)
- ▶ Compatible with 280mm x 280mm Dynafix by System 3R

\$3,700
MSRP

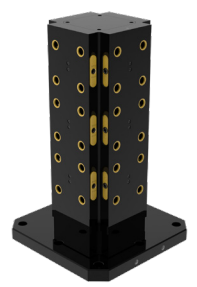
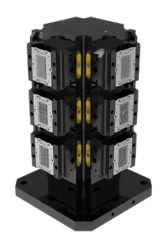
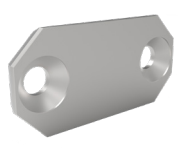
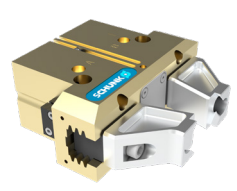

More solutions available at fifthaxis.com